



MOLD FITTINGS

Booklet 2024

ชิ้นส่วนติดตั้งน้ำแม่พิมพ์ฉีดพลาสติก



G-Type

21101 21201

ข้อต่อคัปปลิ่งแม่พิมพ์แบบสไตส์ของเยอรมัน
German style mold couplings.



Body : Brass
Seal : Viton

Max. Temperature 200°C
Max. Pressure 1470kPa

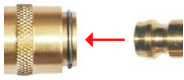

เลือกข้อต่อฟิตติง (fitting) เพื่อใช้กับ คัปปลิ่ง (coupling) ในรุ่น **matching** เดียวกัน
เช่นฟิตติงระบุรุ่น G101 ใช้ร่วมกับคัปปลิ่งที่ระบุรุ่น G101 ได้

Choose **fitting** and **coupling** in the same **matching** to fit together.
Example: fitting in G101 series match coupling in G101 series.

โมลด์คัปปลิ่ง

Mold Coupling

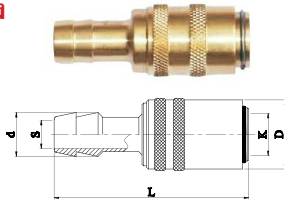

Order Code		Matching Fitting	D	L	d	K	S
Valve	No Valve						
21101-3	21101-3-0	G 101	17	53	10	9	6
21101-4	21101-4-0				14		9
21201-3	21201-3-0	G 201	22	62	10	13.5	6
21201-4	21201-4-0				14		9

โมลด์คัปปลิ่งหักศอก 90°

Mold Coupling Elbow 90°

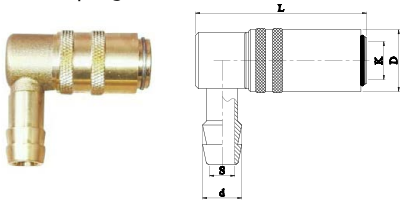

Order Code		Matching Fitting	D	L	d	K	S
Valve	No Valve						
21101-L3	21101-L3-0	G 101	17	41	10	9	6
21101-L4	21101-L4-0			46	14		9
21201-L3	21201-L3-0	G 201	22	51	10	13.5	6
21201-L4	21201-L4-0			14	9		

โมลด์คัปปลิ่งหักศอก 45°

Mold Coupling Elbow 45°

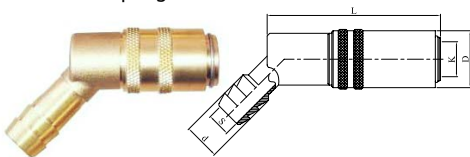

Order Code		Matching Fitting	D	L	d	K	S
Valve	No Valve						
21101-Y3	21101-Y3-0	G 101	17	41	10	9	6
21101-Y4	21101-Y4-0			46	14		9
21201-Y3	21201-Y3-0	G 201	22	51	10	13.5	6
21201-Y4	21201-Y4-0			14	9		

โมลด์คัปปลิ่ง เกลียวตัวเมีย

Female Mold Coupling

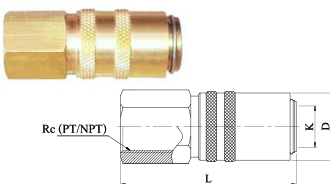

Order Code		Matching Fitting	D	L	Rc	K
Valve	No Valve					
21101-A1/4	21101-A1/4-0	G 101	17	46.5	1/4BSPT	9
21101-A3/8	21101-A3/8-0				3/8BSPT	
21201-A1/4	21201-A1/4-0	G 201	22	56.5	1/4BSPT	13.5
21201-A3/8	21201-A3/8-0				3/8BSPT	

G-Type 21101 21201

☉ OIL FREE™

โมลด์คัปปลิ่ง เกลียตัวผู้

Male Mold Coupling

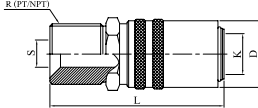

Order Code		Matching Fitting	D	L	R	K	S
Valve	No Valve						
21101-M10	21101-M10-0	G 101	17	50.5	M10x1	9	6
21101-M14	21101-M14-0			54.5	M14x1.5		8
21101-1/4	21101-1/4-0			51.5	1/4BSPT		8
21101-3/8	21101-3/8-0				3/8BSPT	10	
21201-1/4	21201-1/4-0	G 201	22	56.5	1/4BSPT	13.5	8
21201-3/8	21201-3/8-0				3/8BSPT		9
21201-1/2	21201-1/2-0			58.5	1/2BSPT	15	

โมลด์คัปปลิ่ง เกลียตัวผู้หักศอก 90°

Male Mold Coupling Elbow 90°

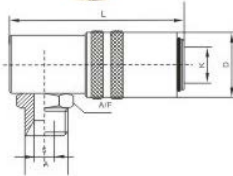

Order Code		Matching Fitting	D	L	R	K	A/F	S
Valve	No Valve							
21101-LM14	21101-LM14-0	G 101	17	46.5	M14x1.5	9	14	6
21101-L1/4	21101-L1/4-0				1/4BSPT			8
21101-L3/8	21101-L3/8-0				3/8BSPT	17	10	
21201-LM14	21201-LM14-0	G 201	22	56.5	M14x1.5	13.5	14	8
21201-L1/4	21201-L1/4-0				1/4BSPT			8
21201-L3/8	21201-L3/8-0				3/8BSPT	17	9	

โมลด์คัปปลิ่ง เกลียตัวผู้หักศอก 45°

Male Mold Coupling Elbow 45°

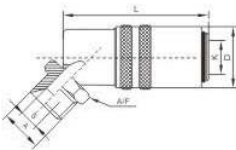

Order Code		Matching Fitting	D	L	R	K	A/F	S
Valve	No Valve							
21101-YM14	21101-YM14-0	G 101	17.2	46.5	M14x1.5	9	14	8
21101-Y1/4	21101-Y1/4-0				1/4BSPT			8
21101-Y3/8	21101-Y3/8-0				3/8BSPT	17	10	
21201-YM14	21201-YM14-0	G 201	22	56.5	M14x1.5	13.5	14	8
21201-Y1/4	21201-Y1/4-0				1/4BSPT			8
21201-Y3/8	21201-Y3/8-0				3/8BSPT	17	10	

G-Type 21101 21201

FOIL FREE™

โมลด์คัปปลิง เปลี่ยนทางน้ำ

Mold Coupling Diverter

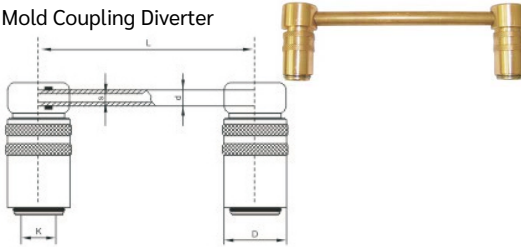

Order Code	Matching Fitting	D	L	K	d	S
21101-B125-0	G 101	17	125	9	8	6
21101-B250-0			250			
21101-B500-0			500			
21201-B125-0	G 201	23	125	13.5	10	8
21201-B250-0			250			
21201-B500-0			500			

โมลด์ฟิตตังนิปเปิ้ล

Mold Fitting Nipple

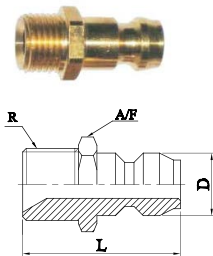

Order Code		Matching Fitting	D	L	R	T	A/F
Valve	No Valve						
-	21101-M10x1-M	G 101	9	24	M10x1	7	11
-	21101-M14x1.5-M			26	M14x1.5	9	15
-	21101-01BSPT-M			24	1/8BSPT	7	11
21101-02BSPTC-M	21101-02BSPT-M	G 201	13.4	26	1/4BSPT	9	15
-	21101-03BSPT-M			26	3/8BSPT	9	17
-	21201-M14x1.5-M			M14x1.5	15		
-	21201-M16x1.5-M	M16x1.5	17				
-	21201-01BSPT-M	1/8BSPT	9	15			
21201-02BSPTC-M	21201-02BSPT-M	1/4BSPT	15				
-	21201-03BSPT-M	3/8BSPT	17				

โมลด์ฟิตตังนิปเปิ้ล หักศอก 90°

Mold Fitting Nipple Elbow 90°

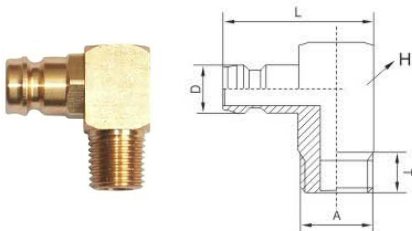

Order Code	Matching Fitting	D	L	R	T	H
No Valve						
21101-M10x1-L	G 101	9	33	M10x1	12	15
21101-M14x1.5-L				M14x1.5		
21101-01BSPT-L				1/8BSPT		
21101-02BSPT-L	G 201	13.4	33	1/4BSPT	12	20
21101-03BSPT-L				3/8BSPT		
21201-M14x1.5-L				M14x1.5		
21201-M16x1.5-L	M16x1.5	20				
21201-01BSPT-L	1/8BSPT	15				
21201-02BSPT-L	1/4BSPT	15				
21201-03BSPT-L	3/8BSPT	20				

G-Type 21101 21201

โมลด์ฟิตติ้งนิปเปิ้ล รุ่นยาว

Mold Fitting Extension Nipple

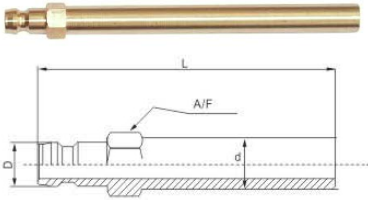

Order Code	Matching Fitting	D	L	d	A/F
No Valve					
21101-120	G 101	9	120	10	11
21101-240			240		
21101-360			360		
21201-150	G 201	13.4	150	14	15
21201-300			300		
21201-450			450		

โมลด์ฟิตติ้งนิปเปิ้ล รุ่นยาวมีเกลียว

Mold Fitting Extension Nipple with Thread

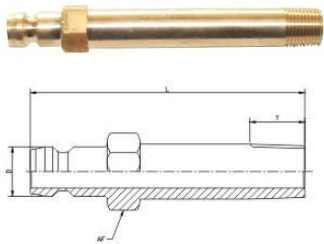

Order Code	Matching Fitting	D	L	T	R	A/F
No Valve						
21101-01BSPT-100M	G 101	9	100	10	1/8" BSPT	11
21101-02BSPT-100M				12	1/4" BSPT	15
21101-03BSPT-100M					3/8" BSPT	17
21201-02BSPT-100M	G 201	13.4	100	12	1/4" BSPT	15
21201-03BSPT-100M					3/8" BSPT	17

โมลด์ฟิตติ้งนิปเปิ้ล หางปลาไหล

Mold Fitting Nipple Hose Barb

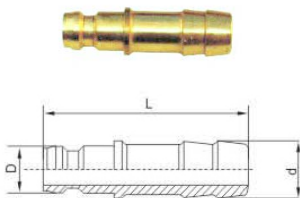

Order Code	Matching Fitting	D	L	d
No Valve				
21101-06-M	G 101	9	34.5	6
21101-08-M				8
21101-10-M				10
21101-13-M				13
21201-13-M	G 201	13.4	35	13

A-Type

ข้อต่อคัปปลิงแม่พิมพ์แบบสไตส์ของอเมริกา
American style mold couplings.

FOIL FREE™

21301 21401



Body : Brass
Seal : Viton

Max. Temperature 200°C
Max. Pressure 1470kPa



เลือกข้อต่อฟิตติง (fitting) เพื่อใช้กับ คัปปลิง (coupling) ในรุ่น **matching** เดียวกัน
เช่น ฟิตติงรุ่น A301 ใช้ร่วมกับคัปปลิงที่รุ่น A301 ได้

Choose **fitting** and **coupling** in the same **matching** to fit together.
Example: fitting in A301 series match coupling in A301 series.

โมลด์คัปปลิงซ็อกเก็ต

Mold Socket

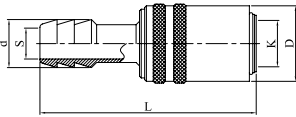

Order Code		Matching Fitting	D	L	d	K	S
Valve	No Valve						
21301-2	21301-2-0	A 301	17	52	7.3	9.7	5
21301-3	21301-3-0				10.5		6
21301-4	21301-4-0				14		9
21301-2L	21301-2L-0			7.3	5		
21301-3L	21301-3L-0			10.5	6		
21301-4L	21301-4L-0			14	9		
-	21401-3-0	A 401	22	55	10.5	13.5	6
-	21401-4-0				14		9
21401-3L	21401-3L-0			10.5	6		
21401-4L	21401-4L-0			14	9		

โมลด์คัปปลิงซ็อกเก็ตหักศอก 90°

Mold Socket Elbow 90°

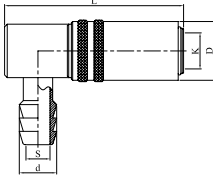

Order Code		Matching Fitting	D	L	d	K	S
Valve	No Valve						
21301-L2	21301-L2-0	A 301	17	46	7.3	9.7	6
21301-L3	21301-L3-0				10.5		6
21301-L4	21301-L4-0				14		9
21401-L3	21401-L3-0	A 401	22	61	10.5	13.5	6
21401-L4	21401-L4-0				14		9

โมลด์คัปปลิงซ็อกเก็ตหักศอก 45°

Mold Socket Elbow 45°

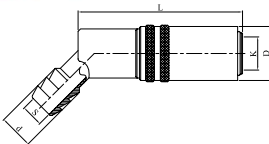

Order Code		Matching Fitting	D	L	d	K	S
Valve	No Valve						
21301-Y2	21301-Y2-0	A 301	17	46	7.3	9.7	6
21301-Y3	21301-Y3-0				10.5		6
21301-Y4	21301-Y4-0				14		9
21401-Y3	21401-Y3-0	A 401	22	61	10.5	13.5	6
21401-Y4	21401-Y4-0				14		9

A-Type 21301 21401

โมลด์คัปปลิ่งซ็อกเก็ต เกลียวตัวเมีย Female Mold Socket

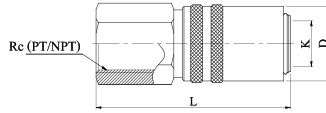

⚠ เกลียวสามารถเลือกได้ระหว่าง PT และ NPT
Choose between PT or NPT thread

PT Order Code		NPT Order Code		Matching Fitting	D	L	Rc (PT/NPT)	K
Valve	No Valve	Valve	No Valve					
21301-A1/8	21301-A1/8-0	21301-AN1/8	21301-AN1/8-0	A 301	17	44	1/8	9.7
21301-A1/4	21301-A1/4-0	21301-AN1/4	21301-AN1/4-0			46	1/4	
21401-A1/4	21401-A1/4-0	21401-AN1/4	21401-AN1/4-0	A 401	22	56	1/4	13.5
21401-A3/8	21401-A3/8-0	21401-AN3/8	21401-AN3/8-0			56	3/8	
21401-A1/2	21401-A1/2-0	21401-AN1/2	21401-AN1/2-0			58	1/2	

โมลด์คัปปลิ่งซ็อกเก็ต เกลียวตัวผู้ Male Mold Socket

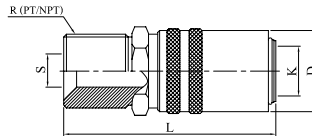

⚠ เกลียวสามารถเลือกได้ระหว่าง PT และ NPT
Choose between PT or NPT thread

PT Order Code		NPT Order Code		Matching Fitting	D	L	Rc (PT/NPT)	K	S
Valve	No Valve	Valve	No Valve						
21301-1/8	21301-1/8-0	21301-N1/8	21301-N1/8-0	A 301	17	46	1/8	9.7	6
21301-1/4	21301-1/4-0	21301-N1/4	21301-N1/4-0			48	1/4		9
21401-1/4	21401-1/4-0	21401-N1/4	21401-N1/4-0	A 401	22	60	1/4	13.5	9
21401-3/8	21401-3/8-0	21401-N3/8	21401-N3/8-0			60	3/8		11
21401-1/2	21401-1/2-0	21401-N1/2	21401-N1/2-0			62	1/2		15

A-Type 21301 21401

โมลด์ฟิตติงปลั๊ก

Mold Fitting Plug

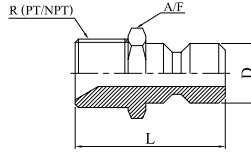

⚠️ เกี่ยวยสามารถเลือกได้ระหว่าง PT และ NPT
Choose between PT or NPT thread

PT Order Code		NPT Order Code		Matching Fitting	D	L	R (PT/NPT)	T	A/F
Valve	No Valve	Valve	No Valve						
-	21301-01PT-M	-	21301-01NPT-M	A 301	9.5	24	1/8	11	
21301-02PTC-M	21301-02PT-M	21301-02NPTC-M	21301-02NPT-M			29	1/4	12	14
-	21301-03PT-M	-	21301-03NPT-M			29	3/8		17
-	21301-04PT-M	-	21301-04NPT-M			31	1/2	14	21
-	21401-01PT-M	-	21401-01NPT-M	A 401	13.5	31	1/8		11
21401-02PTC-M	21401-02PT-M	21401-02NPTC-M	21401-02NPT-M			34	1/4	12	14
-	21401-03PT-M	-	21401-03NPT-M			34	3/8		17
-	21401-04PT-M	-	21401-04NPT-M			36	1/2	14	21

โมลด์ฟิตติงปลั๊ก หักศอก 90°

Mold Fitting Plug Elbow 90°

⚠️ เกี่ยวยสามารถเลือกได้ระหว่าง PT และ NPT
Choose between PT or NPT thread

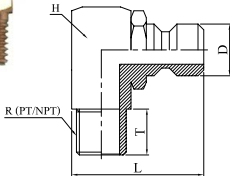
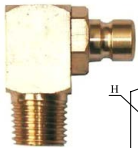

PT Order Code	NPT Order Code	Matching Fitting	D	L	R (PT/NPT)	T	H
No Valve	No Valve						
21301-01PT-L	21301-01NPT-L	A 301	9.5	29.5	1/8	12	15
21301-02PT-L	21301-02NPT-L			34.5	3/8	14	20
21301-03PT-L	21301-03NPT-L						
21401-01PT-L	21401-01NPT-L	A 401	13.5	34.5	1/8	12	15
21401-02PT-L	21401-02NPT-L			39.5	3/8	14	20
21401-03PT-L	21401-03NPT-L						

โมลด์ฟิตติงปลั๊ก หางปลาไหล

Mold Fitting Plug Hose Barb

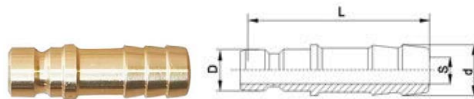

Order Code	Matching Fitting	D	L	d
21301-10-M	A 301	9.5	36	10.5
21401-13-M	A 401	13.5	40	14

A-Type 21301 21401

โมลด์ฟิตติ้งปลั๊ก รุ่นยาว

Mold Fitting Extension Plug

⚠️ เกือบจะสามารถเลือกได้ระหว่าง PT และ NPT
Choose between PT or NPT thread

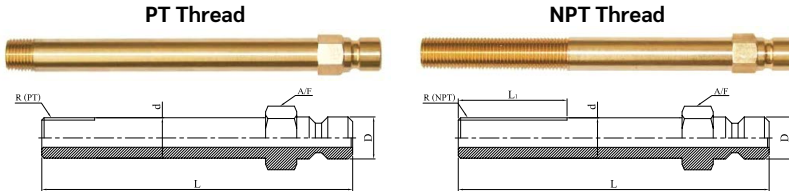

L	L1
50	20
75	30
100	50
125	60
150	60
200	60

ORDER EXAMPLE Model - L
21301-01PT-50 ⚠️ ความยาว 250 สำหรับรุ่นเกลียว PT เท่านั้น
The length 250 for PT thread only

PT Model No Valve	NPT Model No Valve	L								Matching Fitting	D	R (PT/NPT)	d	A/F
21301-01PT	21301-01NPT									A 301	9.5	1/8	10	11
21301-02PT	21301-02NPT	50	75	100	125	150	200	250*	1/4			13	14	
21301-03PT	-								3/8			16.5	17	
21401-01PT	21401-01NPT									A 401	13.5	1/8	10	14
21401-02PT	21401-02NPT	50	75	100	125	150	200	250*	1/4			13	14	
21401-03PT	-								3/8			16.5	17	

โมลด์คัปปลิ้งซีลอกเก็ต รุ่นอัลลอยเบา

Light Alloy Mold Socket

ผลิตจากวัสดุน้ำหนักเบา ความแข็งแรงเทียบเท่าทองเหลือง
Lighter than brass coupling with similar strength.

Ⓜ Body : Light Alloy Seal : Viton ⚠️ Max. Temperature 200°C
Max. Pressure 1470kPa

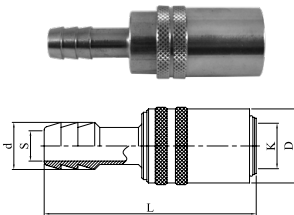

Order Code No Valve	Matching Fitting	D	L	d	K	S
21LA301-2-0	A 301	17	52	7.3	9.7	5
21LA301-3-0				10.5		6
21LA401-3-0	A 401	22	55	10.5	13.5	6
21LA401-4-0				14		9
21LA401-3L-0				10.5		6
21LA401-4L-0		22	63	14	13.5	9

โมลด์ฟิตติ้งปลั๊ก รุ่นอัลลอยเบา

Light Alloy Mold Fitting Plug

ผลิตจากวัสดุน้ำหนักเบา ความแข็งแรงเทียบเท่าทองเหลือง
Lighter than brass coupling with similar strength.

Ⓜ Body : Light Alloy Seal : Viton ⚠️ Max. Temperature 200°C
Max. Pressure 1470kPa

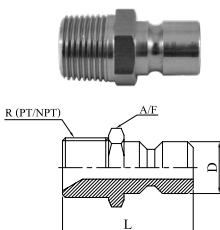

PT Order Code No Valve	NPT Order Code No Valve	Matching Fitting	D	L	R (PT/NPT)	T	A/F
21LA301-01PT-M	21LA301-01NPT-M	A 301	9.5	29	1/8	12	11
21LA301-02PT-M	21LA301-02NPT-M				1/4		14
21LA401-01PT-M	21LA401-01NPT-M				1/8	11	
21LA401-02PT-M	21LA401-02NPT-M	A 401	13.5	34	1/4	12	14
21LA401-03PT-M	21LA401-03NPT-M				3/8		17

J-Type

ข้อต่อคัปปลิ่งแม่พิมพ์แบบสไตส์ของญี่ปุ่น
Japan style mold couplings.

FOIL FREE™

21601 21701



Body : Brass
Seal : Viton

Max. Temperature 200°C
Max. Pressure 1470kPa

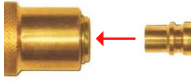

เลือกข้อต่อฟิตติง (fitting) เพื่อใช้กับ คัปปลิ่ง (coupling) ในรุ่น **matching** เดียวกัน
เช่นฟิตติงตระกูล J601 ใช้ร่วมกับคัปปลิ่งที่ระบุรุ่น J601 ได้

Choose **fitting** and **coupling** in the same **matching** to fit together.
Example: fitting in J601 series match coupling in J601 series.

โมลด์คัปปลิ่งซ็อกเก็ต SH

Mold Socket SH

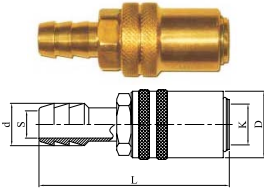

Order Code		Matching Fitting	D	L	d	K	S
Valve	No Valve						
21601-2	21601-2-0	J 601	21	61	8.5	10.0	4.5
21601-3	21601-3-0				11.0		6.0
21601-4	21601-4-0				14.0		9.0
21701-3	21701-3-0	J 701	26	77	11.0	13.0	6.0
21701-4	21701-4-0				14.0		9.0

โมลด์คัปปลิ่งซ็อกเก็ตหักศอก 90° SHL

Mold Socket Elbow 90° SHL

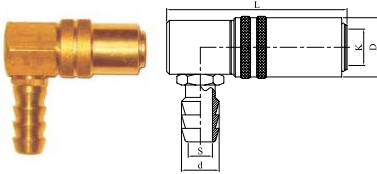

Order Code		Matching Fitting	D	L	d	K	S
Valve	No Valve						
21601-L2	21601-L2-0	J 601	21	48	8.5	10.0	4.5
21601-L3	21601-L3-0				11.0		6.0
21601-L4	21601-L4-0				14.0		9.0
21701-L3	21701-L3-0	J 701	26	55	11.0	13.0	6.0
21701-L4	21701-L4-0				14.0		9.0

โมลด์คัปปลิ่งซ็อกเก็ต เกลียวตัวผู้ SM

Male Mold Socket SM

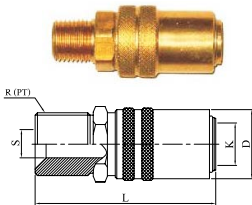

Order Code		Matching Fitting	D	L	R (PT)	K	S
Valve	No Valve						
21601-1/4	21601-1/4-0	J 601	21	51	1/4PT	10.0	8.0
21601-3/8	21601-3/8-0				3/8PT		8.0
21701-1/4	21701-1/4-0	J 701	26	55	1/4PT	13.0	9.0
21701-3/8	21701-3/8-0				3/8PT		11.0

J-Type 21601 21701

โมลด์คัปปลิ่งซ็อกเก็ต เกลียวตัวเมีย SF

Female Mold Socket SF

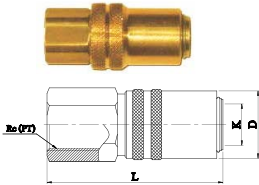

Order Code		Matching Fitting	D	L	Rc (PT)	K
Valve	No Valve					
21601-A1/4	21601-A1/4-0	J 601	21	48	1/4PT	10.0
21601-A3/8	21601-A3/8-0				3/8PT	
21701-A1/4	21701-A1/4-0	J 701	26	55	1/4PT	13.0
21701-A3/8	21701-A3/8-0				3/8PT	

โมลด์ฟิตติ้งปลั๊ก PM

Mold Fitting Plug PM

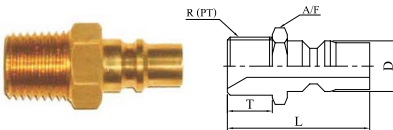

Order Code No Valve	Matching Fitting	D	L	R (PT)	T	A/F
21601-01PT-M	J 601	10.0	33.0	1/8PT	12.0	11.0
21601-02PT-M				1/4PT		14.0
21601-03PT-M				3/8PT		17.0
21701-01PT-M	J 701	13.0	38.0	1/8PT	12.0	14.0
21701-02PT-M				1/4PT		17.0
21701-03PT-M				3/8PT		17.0

โมลด์ฟิตติ้งปลั๊ก หักศอก 90° PML

Mold Fitting Plug Elbow 90° PML

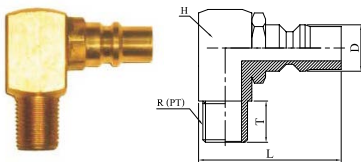

Order Code No Valve	Matching Fitting	D	L	R (PT)	T	A/F
21601-01PT-L	J 601	10.0	34.0	1/8PT	12.0	15.0
21601-02PT-L			1/4PT			
21601-03PT-L			3/8PT	20.0		
21701-01PT-L	J 701	13.0	39.0	1/8PT	12.0	15.0
21701-02PT-L			1/4PT			
21701-03PT-L			3/8PT	20.0		

โมลด์ฟิตติ้งปลั๊ก รูนยาว PME

Mold Fitting Extension Plug PME

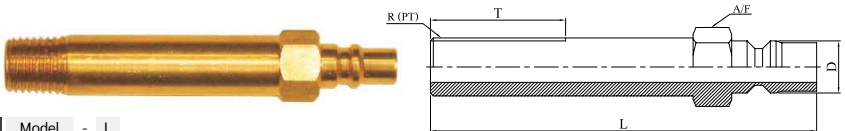

ORDER	Model - L
EXAMPLE	21601-01PT-75

Model No Valve	L						Matching Fitting	D	R (PT)	T	A/F
21601-01PT	75	100	125	150	200	250	J 601	10.0	1/8PT	12.0	11.0
21601-02PT									1/4PT		14.0
21701-01PT	75	100	125	150	200	250	J 701	13.0	1/8PT	12.0	14.0
21701-02PT									1/4PT		

คัปปลิงแบบขันน็อต

Fastening Coupling

FOIL FREE™

21S-NKC

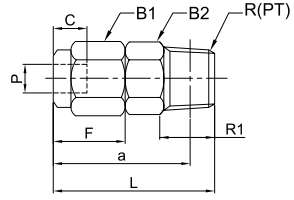
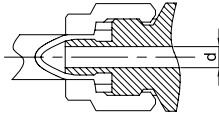

ORDER
EXAMPLE

Model P - No.
21S-NKC8-02

M Brass ! Max. Temperature 180°C

Model	P	No.	R (PT)	Tube OD x ID	C	d	L	a	F	B1	R1	B2
21S-NKC	6	01	1/8PT	6 x 4	6	3.0	25.5	21.5	11.5	12	8	12
		02	1/4PT				28.5	22.5			11	14
		03	3/8PT				29.5	23.2			12	17
	8	01	1/8PT	8 x 6	7	5.0	27.5	23.5	13.5	14	8	14
		02	1/4PT				30.5	24.5			11	14
		03	3/8PT				31.5	25.2			12	17
	10	02	1/4PT	10 x 7.5	9	6.0	33.5	27.5	16.5	17	11	17
		03	3/8PT				34.5	28.2			12	17
		04	1/2PT				37.5	29.3			15	21
	12	02	1/4PT	12 x 9	9	7.5	33.5	27.5	16.5	19	11	19
		03	3/8PT				34.5	28.2			12	19
		04	1/2PT				37.5	29.3			15	21

คัปปลิงแบบขันน็อต หักศอก

Fastening Coupling Elbow

FOIL FREE™

21S-NKL

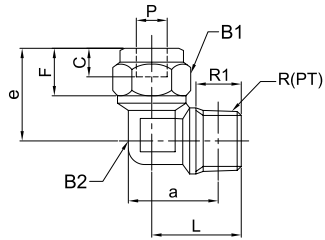
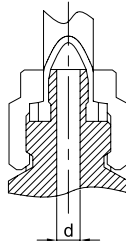

ORDER
EXAMPLE

Model P - No.
21S-NKL8-02

M Brass ! Max. Temperature 180°C

Model	P	No.	R (PT)	Tube OD x ID	C	d	L	a	e	F	B1	R1	B2
21S-NKL	6	01	1/8PT	6 x 4	6	3.0	21	23.9	21	11.5	12	8	12
		02	1/4PT				22	24.1	22			11	14
		03	3/8PT				29	33.6	29			12	19
	8	01	1/8PT	8 x 6	7	5.0	25	30.8	25	13.5	14	8	17
		02	1/4PT				25	28.8	25			11	17
		03	3/8PT				29	33.6	29			12	19
	10	02	1/4PT	10 x 7.5	9	6.0	29	34.0	29	16.5	17	11	19
		03	3/8PT				29	33.6	29			12	19
		04	1/2PT				31	36.1	31			15	23
	12	02	1/4PT	12 x 9	9	7.5	29	34.0	29	16.5	19	11	19
		03	3/8PT				29	33.6	29			12	19
		04	1/2PT				31	36.1	31			15	23

ข้อต่อลมสวมเร็ว พลาสติก C-Series

21CPLA

Oil Free™

Plastic C-Series pneumatic quick coupling



Port Size
สวมสายยาง
Hose Port

SP

21CPLA-SP

Order Code	Port Size
21CPLA-SP-20	5x8mm
21CPLA-SP-30	6.5x10mm
21CPLA-SP-40	8x12mm



Port Size
เกลียวตัวผู้
Male Thread

SM

21CPLA-SM

Order Code	Port Size
21CPLA-SM-20	1/4PT
21CPLA-SM-30	3/8PT
21CPLA-SM-40	1/2PT



Port Size
สวมสายยาง
Hose Port

SH

21CPLA-SH

Order Code	Port Size
21CPLA-SH-20	9mm
21CPLA-SH-30	11mm
21CPLA-SH-40	13mm



Port Size
เกลียวตัวเมีย
Female Thread

SF

21CPLA-SF

Order Code	Port Size
21CPLA-SF-20	1/4PT
21CPLA-SF-30	3/8PT
21CPLA-SF-40	1/2PT



Port Size
สวมสายยาง
Hose Port

PP

21CPLA-PP

Order Code	Port Size
21CPLA-PP-20	5x8mm
21CPLA-PP-30	6.5x10mm
21CPLA-PP-40	8x12mm



Port Size
เกลียวตัวผู้
Male Thread

PM

21CPLA-PM

Order Code	Port Size
21CPLA-PM-20	1/4PT
21CPLA-PM-30	3/8PT
21CPLA-PM-40	1/2PT



Port Size
สวมสายยาง
Hose Port

PH

21CPLA-PH

Order Code	Port Size
21CPLA-PH-20	9mm
21CPLA-PH-30	11mm
21CPLA-PH-40	13mm



Port Size
เกลียวตัวเมีย
Female Thread

PF

21CPLA-PF

Order Code	Port Size
21CPLA-PF-20	1/4PT
21CPLA-PF-30	3/8PT
21CPLA-PF-40	1/2PT



Port Size
เกลียวตัวเมีย
Female Thread

SMV

21CPLA-SMV

Order Code	Port Size
21CPLA-SMV	1/4PT



Port Size
เกลียวตัวเมีย
Female Thread

SMY

21CPLA-SMY

Order Code	Port Size
21CPLA-SMY	1/4PT

Working pressure: 0~0.9MPa
Max. pressure: 1.32Mpa
Fluid temperature: 0~60 °C
Recommended tube: PU, Nylon

ข้อต่อสวมเร็ว

Quick Fitting Joints

ORDER	Model	D - Nominal
EXAMPLE	21SPC8-02PT	

FOIL FREE™

Model: 21SPC
เกลียวตัวผู้
Male Thread



Model	Matching Tube O.D.		Thread Size		
	D	Nominal	R(PT)		
21SPC	4	01PT	1/8PT		
		02PT	1/4PT		
		03PT	3/8PT		
	6	01PT	1/8PT		
		02PT	1/4PT		
		03PT	3/8PT		
	8	04PT	1/2PT		
		01PT	1/8PT		
		02PT	1/4PT		
	10	03PT	3/8PT		
		04PT	1/2PT		
		02PT	1/4PT		
12	03PT	3/8PT			
	04PT	1/2PT			
	03PT	3/8PT			
16	04PT	1/2PT			
	06PT	3/4PT			

Model: 21SPOC
เกลียวตัวผู้ รูทรงหกเหลี่ยม
Male Thread
Hexagon Hole



Model	Matching Tube O.D.		Thread Size	
	D	Nominal	R(PT)	
21SPOC	6	01PT	1/8PT	
		02PT	1/4PT	
	8	01PT	1/8PT	
		02PT	1/4PT	
	10	01PT	1/8PT	
		02PT	1/4PT	

Model: 21SPCF
เกลียวตัวเมีย
Female Thread



Model	Matching Tube O.D.		Thread Size	
	D	Nominal	Rc(PT)	
21SPCF	4	01PT	1/8PT	
		02PT	1/4PT	
	6	01PT	1/8PT	
		02PT	1/4PT	
		03PT	3/8PT	
	8	01PT	1/8PT	
		02PT	1/4PT	
		03PT	3/8PT	
	10	04PT	1/2PT	
		01PT	1/8PT	
		02PT	1/4PT	
	12	03PT	3/8PT	
04PT		1/2PT		
02PT		1/4PT		

Model: 21SPLL
เกลียวตัวผู้ ทักศอก
Male Elbow



Model	Matching Tube O.D.		Thread Size		
	D	Nominal	R(PT)		
21SPLL	4	01PT	1/8PT		
		02PT	1/4PT		
		03PT	3/8PT		
	6	01PT	1/8PT		
		02PT	1/4PT		
		03PT	3/8PT		
	8	01PT	1/8PT		
		02PT	1/4PT		
		03PT	3/8PT		
	10	04PT	1/2PT		
		01PT	1/8PT		
		02PT	1/4PT		
	12	03PT	3/8PT		
		04PT	1/2PT		
		02PT	1/4PT		
	16	03PT	3/8PT		
		04PT	1/2PT		
		06PT	3/4PT		

Model: 21SPLFL
เกลียวตัวเมีย ทักศอก
Female Elbow



Model	Matching Tube O.D.		Thread Size	
	D	Nominal	R(PT)	
21SPLFL	4	01PT	1/8PT	
		02PT	1/4PT	
	6	01PT	1/8PT	
		02PT	1/4PT	
		03PT	3/8PT	
	8	01PT	1/8PT	
		02PT	1/4PT	
		03PT	3/8PT	
	10	04PT	1/2PT	
		01PT	1/8PT	
		02PT	1/4PT	
	12	03PT	3/8PT	
04PT		1/2PT		
02PT		1/4PT		

ข้อต่อสวมเร็ว

Quick Fitting Joints

ORDER	Model	D - Nominal
EXAMPLE	21SPLEL8-02PT	

☉ OIL FREE™

Model: 21SPLEL
เกลียวยาวตัวผู้ ทักศอก
Extended
Male Elbow



Model	Matching Tube O.D.	Thread Size	
		D	R(PT)
21SPLEL	4	01PT	1/8PT
		02PT	1/4PT
		03PT	3/8PT
	6	01PT	1/8PT
		02PT	1/4PT
		03PT	3/8PT
	8	01PT	1/8PT
		02PT	1/4PT
		04PT	1/2PT
10	01PT	1/8PT	
	02PT	1/4PT	
	04PT	1/2PT	
12	02PT	1/4PT	
	03PT	3/8PT	
	04PT	1/2PT	

Model: 21SPH
เกลียวตัวผู้ แบบใจหักศอก
Male Banjo



Model	Matching Tube O.D.	Thread Size	
		D	R(PT)
21SPH	4	01PT	1/8 PT
		02PT	1/4 PT
		03PT	3/8 PT
	6	01PT	1/8 PT
		02PT	1/4 PT
		03PT	3/8 PT
	8	01PT	1/8 PT
		02PT	1/4 PT
		03PT	3/8 PT
10	01PT	1/8 PT	
	02PT	1/4 PT	
	03PT	3/8 PT	
12	02PT	1/4 PT	
	03PT	3/8 PT	
	04PT	1/2 PT	

Model: 21SLL
เกลียวตัวผู้
มีวาล์วปรับระดับ
Male Thread
Flow Control Valve



Model	Matching Tube O.D.	Thread Size	
		D	R(PT)
21SLL	4	01PT	1/8PT
		02PT	1/4PT
		03PT	3/8PT
	6	01PT	1/8PT
		02PT	1/4PT
		03PT	3/8PT
	8	01PT	1/8PT
		02PT	1/4PT
		03PT	3/8PT
10	01PT	1/8PT	
	02PT	1/4PT	
	04PT	1/2PT	
12	02PT	1/4PT	
	03PT	3/8PT	
	04PT	1/2PT	
16	02PT	1/4PT	
	03PT	3/8PT	
	04PT	1/2PT	

Model: 21SPXY
เกลียวตัวผู้ ตัว Y
Male Thread Y



Model	Matching Tube O.D.	Thread Size	
		D	R(PT)
21SPXY	4	01PT	1/8PT
		02PT	1/4PT
		03PT	3/8PT
	6	01PT	1/8PT
		02PT	1/4PT
		03PT	3/8PT
	8	01PT	1/8PT
		02PT	1/4PT
		03PT	3/8PT
	10	04PT	1/2PT
		01PT	1/8PT
		02PT	1/4PT
	12	03PT	3/8PT
		04PT	1/2PT
		02PT	1/4PT
	16	03PT	3/8PT
		04PT	1/2PT
		06PT	3/4PT

ข้อต่อสวมเร็ว

Quick Fitting Joints

ORDER	Model	D - Nominal
EXAMPLE	21SPBT8-02PT	

FOIL FREE™

Model: 21SPBT
เกลียวตัวผู้ ตัว T
Male Thread T



Model	Matching Tube O.D. D	Thread Size	
		Nominal	R(PT)
21SPBT	4	01PT	1/8PT
		02PT	1/4PT
		03PT	3/8PT
	6	01PT	1/8PT
		02PT	1/4PT
		03PT	3/8PT
	8	01PT	1/8PT
		02PT	1/4PT
		03PT	3/8PT
	10	04PT	1/2PT
		01PT	1/8PT
		02PT	1/4PT
12	03PT	3/8PT	
	04PT	1/2PT	
	02PT	1/4PT	
16	03PT	3/8PT	
	04PT	1/2PT	
	06PT	3/4PT	

Model: 21SPDT
เกลียวตัวผู้ ตัว T ข้าง
Male Thread T Side



Model	Matching Tube O.D. D	Thread Size	
		Nominal	R(PT)
21SPDT	4	01PT	1/8PT
		02PT	1/4PT
		03PT	3/8PT
	6	01PT	1/8PT
		02PT	1/4PT
		03PT	3/8PT
	8	04PT	1/2PT
		01PT	1/8PT
		02PT	1/4PT
	10	03PT	3/8PT
		04PT	1/2PT
		01PT	1/8PT
12	02PT	1/4PT	
	03PT	3/8PT	
	04PT	1/2PT	
16	03PT	3/8PT	
	04PT	1/2PT	
	06PT	3/4PT	

ข้อลด

Reducers

ORDER	Model	D1 - D2
EXAMPLE	21SPG10-8	

Model: 21SPG
ข้อลดแบบตรง
Union Straight Reducer



Model	Matching Tube O.D.	
	D1	D2
21SPG	6	4
	8	4
		6
	10	6
		8
	12	8
10		
16	12	

Model: 21SPWY
ข้อลดแบบตัว Y
Union Y Reducers



Model	Matching Tube O.D.	
	D1	D2
21SPWY	6	4
	8	4
		6
	10	6
		8
	12	8
10		

Model: 21SPEGT
ข้อลดแบบตัว T
Union T Reducers



Model	Matching Tube O.D.	
	D1	D2
21SPEGT	6	4
	8	4
		6
	10	6
		8
	12	8
10		

Model: 21SPKG
ข้อลดแบบแฉก
Union Branch Reducers



Model	Matching Tube O.D.	
	D1	D2
21SPKG	6	4
	8	4
		6
	10	6
		8
	12	8
10		

ข้อต่อสวมเร็ว

Quick Fitting Joints

ข้อต่อตรง

Unions

Model: 21SLSA
ข้อต่อตรง มีวาล์ว
ปรับระดับ
Union Flow
Control Valve



ORDER	Model	D
EXAMPLE	21SPU8	

Model	Matching Tube O.D.
	D
21SLSA	4
	6
	8
	10
	12

Model: 21SPU
ข้อต่อตรง
Union Straight



Model	Matching Tube O.D.
	D
21SPU	4
	6
	8
	10
	12
	16

Model: 21SPV
ข้อต่อหักศอก
Union Elbow



Model	Matching Tube O.D.
	D
21SPV	4
	6
	8
	10
	12
	16

Model: 21SPY
ข้อต่อตัว Y
Union Y



Model	Matching Tube O.D.
	D
21SPY	4
	6
	8
	10
	12
	16

Model: 21SPE
ข้อต่อตัว T
Union T



Model	Matching Tube O.D.
	D
21SPE	4
	6
	8
	10
	12
	16

Model: 21SPM
ข้อต่อตรง
Bulkhead Union



Model	Matching Tube O.D.
	D
21SPM	4
	6
	8
	10
	12

Model: 21SPZA
ข้อต่อสี่ทาง
Union Cross



Model	Matching Tube O.D.
	D
21SPZA	4
	6
	8
	10
	12

Model: 21SPK
ข้อต่อแบบแฉก
Union Branch



Model	Matching Tube O.D.
	D
21SPK	4
	6
	8
	10
	12

Model: 21HVFF
ข้อต่อตรง วาล์วเปิด/ปิด
Union Shutoff Valve



Model	Matching Tube O.D.
	D
21HVFF	4
	6
	8

แบบแฉกมีเกลียว

Triple Branch

Model: 21SPKB
แบบแฉกมีเกลียว
Triple Branch



ORDER	Model	D	Nominal
EXAMPLE	21PKB8-02PT		

Model	Matching Tube O.D.	Thread Size	
		D	R(PT)
21SPKB	4	01PT	1/8PT
		02PT	1/4PT
		03PT	3/8PT
	6	01PT	1/8PT
		02PT	1/4PT
		03PT	3/8PT
8	01PT	1/8PT	
	02PT	1/4PT	
	03PT	3/8PT	
10	02PT	1/4PT	
	03PT	3/8PT	

Model: 21SPKD
แบบแฉก มีเกลียว ตัวเมีย
Triple Branch
Female Thread



Model	Matching Tube O.D.	Thread Size	
		D	Rc(PT)
21SPKD	4	01PT	1/8PT
		02PT	1/4PT
		03PT	3/8PT
	6	01PT	1/8PT
		02PT	1/4PT
		03PT	3/8PT
8	01PT	1/8PT	
	02PT	1/4PT	
	03PT	3/8PT	
10	02PT	1/4PT	
	03PT	3/8PT	

ข้อต่อหางปลาไหล

FOIL FREE™

Hose Nipple

21CT

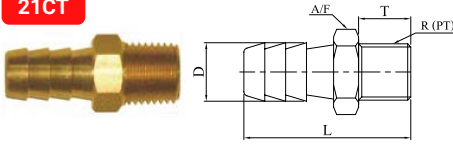

Ⓜ Body : Brass ⚠ Max. Pressure 1470kPa

Order Code	D	R(PT)	For Hose I.D.	T	A/F
21CT-301PT-M	11	1/8PT	9 (3/8")	12.	11
21CT-302PT-M		1/4PT			14
21CT-303PT-M		3/8PT			17
21CT-401PT-M	14	1/8PT	12 (1/2")	12.	11
21CT-402PT-M		1/4PT			14
21CT-403PT-M		3/8PT			17

ข้อต่อหางปลาไหล รุ่นยาว

FOIL FREE™

Long Hose Nipple

21CT

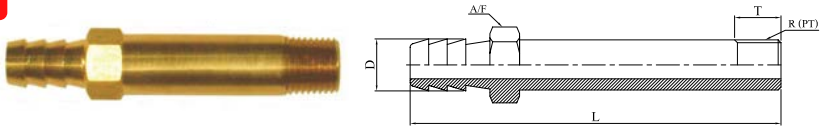

ORDER Model - L
EXAMPLE 21CT-302PT-100 Ⓜ Body : Brass ⚠ Max. Pressure 1470kPa

Model	L							D	R (PT)	For Hose I.D.	T	A/F
21CT-301PT	50	75	100	125	150	200	250	11	1/8PT	9 (3/8")	12	11
21CT-302PT									1/4PT			14
21CT-303PT									3/8PT			17
21CT-401PT								14	12 (1/2")	12	1/8PT	11
21CT-402PT											1/4PT	14
21CT-403PT											3/8PT	17

ข้อต่อหางปลาไหล หัวหมุนได้

FOIL FREE™

L-Swivel Hose Nipple

21LSN

ข้อต่อหางปลาไหลรูปตัว L หัวหมุนได้ 360 องศา สำหรับสวมสายยาง The L-shape Hose Nipple head can rotate 360 degree.

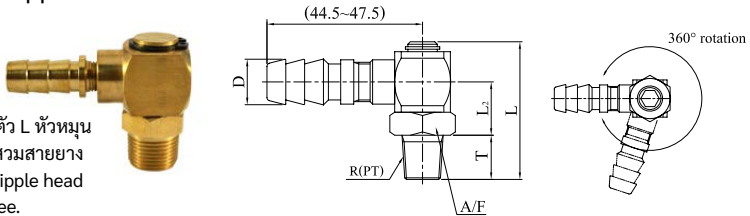

Ⓜ Brass (Body) ⚠ Max pressure 980 kPa
Synthetic Rubber Seal ⚠ Max Temperature 200°C

Order Code	D	R(PT)	For Hose I.D.	L	L2	A/F	T
21LSN-1	11	1/8PT	9 (3/8")	36.5	15.75	19	9.5
21LSN-2		1/4PT		39.5	15.75	19	12.5
21LSN-3		3/8PT		42.5	17.75	19	13.5

ข้อต่อ หัวหมุนได้

L-Swivel Fitting



21LSNF

ข้อต่อรูปตัว L หัวหมุนได้ 360 องศา

The L-shape head can rotate 360 degree.

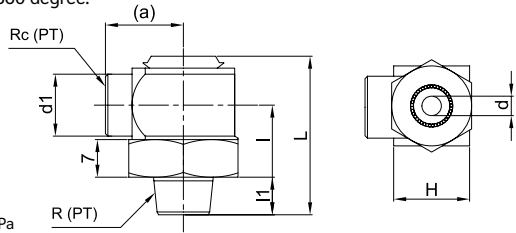

- M** Brass (Body)
Synthetic Rubber Seal
- !** Max pressure 980 kPa
Max Temperature 200°C

Order Code	Rc (PT)	R (PT)	d1	L	l	l1	a
21LSNF-1	1/8PT	1/8PT	14	34	14.5	9.5	16
21LSNF-2	1/4PT	1/4PT	17	42.5	17	12.5	22
21LSNF-3	3/8PT	3/8PT	19				

บอลวาล์วทองเหลือง

Ball Valve 21VC/21VCN

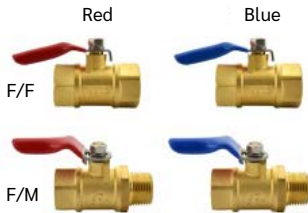

ทองเหลือง | Brass
Model: 21VC

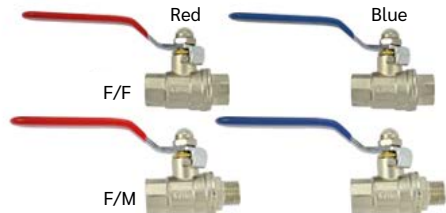

ชุบนิเกิล | Nickel Plated
Model: 21VCN

- M** Brass (Body)
Resin (Handle)
- !** Max. Pressure 1470 kPa
- i** เลือกสีตามและ ประเภทเกลียวตัวผู้/ตัวเมีย
Choose handle color and thread type

Order Code	Handle	Type	Thread	Body
21VC-02PT	Red	F/F	1/4PT	Brass
21VC-03PT			3/8PT	
21VC-04PT			1/2PT	
21VC-02PTB	Blue	F/F	1/4PT	Brass
21VC-03PTB			3/8PT	
21VC-04PT-4			1/2PT	
21VC-02PT-2	Red	F/M	1/4PT	Brass
21VC-03PT-3			3/8PT	
21VC-04PT-4			1/2PT	
21VC-02PT-2B	Blue	F/M	1/4PT	Brass
21VC-03PT-3B			3/8PT	
21VCN-02PT			Red	
21VCN-03PT	3/8PT			
21VCN-02PTB	1/4PT			
21VCN-03PTB	Blue	F/F	3/8PT	Nickel Plated
21VCN-02PT-2			1/4PT	
21VCN-02PT-2B			1/4PT	

คูวลิ่งจ๊อยท์

Cooling Joint Plug

FOIL FREE™

21JN

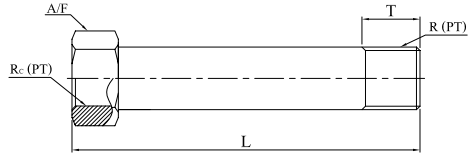

ORDER EXAMPLE

Model - L
21JN01-01PT-75



Brass



Max. Pressure 980 kPa

Model	L							T	Rc	R	A/F
21JN01-01PT	50	75	100	125	150	200	250	12.0	1/8PT	1/8PT	14.0
21JN01-02PT								12.0	1/8PT	1/4PT	14.0
21JN02-01PT								12.0	1/4PT	1/8PT	17.0
21JN02-02PT								12.0	1/4PT	1/4PT	17.0
21JN03-03PT								12.0	3/8PT	3/8PT	21.0

โฟลวมิเตอร์

Water Flow Meter

สำหรับตรวจสอบทางการเดินของน้ำหล่อเย็นในแม่พิมพ์
To check the flow direction of cooling water.

FOIL FREE™

21FM

Body : Brass
Scale : Plastic

Max Pressure 900 kPa
Max Flow Rate 10L/Min
Max Temperature 80°C



21FM-03PT

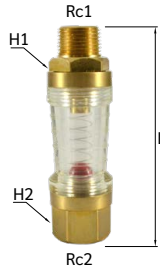

21FM-03PT-3

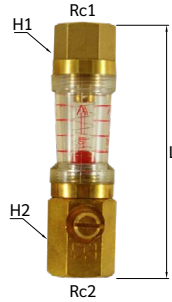

21FMV-03PT



21FMK-03PT

Order Code	Type	H1 (Hexagon)	H2 (Hexagon)	Rc1 (Thread)	Rc2 (Thread)	L
21FM-03PT	Double female thread	21	21	Female 3/8PT	Female 3/8PT	84
21FM-03PT-3	Male + Female thread	21	21	Male 3/8PT	Female 3/8PT	81
21FMV-03PT	Double female thread+valve	21	23	Female 3/8PT	Female 3/8PT	97.5
21FMK-03PT	Male + Female thread	23	21	Male 3/8PT	Female 3/8PT	125

ท่อสายยางยูนิจอยท์

Flexible Uni-Joint Plugs

21FC

FOIL FREE™

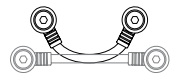
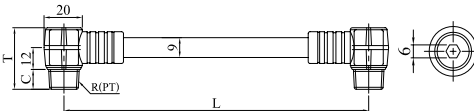

Order Code	R (PT)	L	T	C	Max Torque
21FC01-140	1/8PT	140	31	9	4.9N-m
21FC02-140	1/4PT	140	35	12.7	8.8N-m

Screw Body: Brass
Tube: Urethane

Max Pressure 1470 kPa
Max Temperature 80°C
For water

สกรูปลั๊กทองเหลือง

Tapered Screw Plug

☉ OIL FREE™

21ES / 21AS

สกรูปลั๊กทองเหลือง เกลียวเทเปอร์สำหรับอุดรูน้ำหล่อเย็นแม่พิมพ์ และของเหลวอื่น ๆ ทนแรงดันได้สูง

For sealing cooling water holes, or other liquid. Withstanding high pressure.

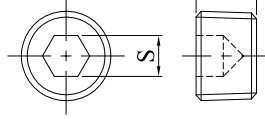

☉ Brass

⚠ Max pressure 4120 kPa
For water / oil / steam

⚠ มีให้เลือกแบบเกลียว PT และ NPT
Available in PT and NPT type

PT Thread

Model: 21ES

Order Code	PT Thread	L (mm)	Hex S (mm)	Thread per Inch
21ES-01PT	1/8PT	7.0	5.0	28
21ES-02PT	1/4PT	8.9	6.0	19
21ES-03PT	3/8PT	10.0	8.0	19
21ES-04PT	1/2PT	12.0	10.0	14
21ES-06PT	3/4PT	14.0	14.0	14
21ES-08PT	1PT	16.5	17.0	11

NPT Thread

Model: 21AS

Order Code	NPT Thread	L (inch)	Hex S (inch)	Thread per Inch
21AS-01NPT	1/8NPT	0.250	3/16	27
21AS-02NPT	1/4NPT	0.406	1/4	18
21AS-03NPT	3/8NPT	0.406	5/16	18
21AS-04NPT	1/2NPT	0.531	3/8	14
21AS-06NPT	3/4NPT	0.531	9/16	14
21AS-08NPT	1NPT	0.656	5/8	11 1/2

ปลั๊กอุดรูน้ำแม่พิมพ์

Cooling Circuit Plug

☉ OIL FREE™

21GCCP

ปลั๊กอุดรูน้ำที่สามารถอุดรูในจุดที่เข้าถึงได้ยากโดยไม่ต้องต๊าปเกลียว
Threadless type sealing plug that can be place almost anywhere.

☉ Body: Brass
O-Ring: Synthetic Rubber

⚠ Max pressure 600 kPa
Max Temperature 100°C
For water / oil

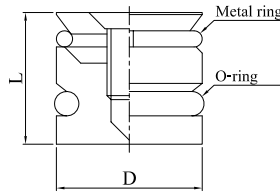

Order Code	D	L
21GCCP06-10	6	10
21GCCP08-10	8	10
21GCCP10-11	10	11
21GCCP12-12	12	12
21GCCP14-13	14	13
21GCCP16-14	16	14
21GCCP18-16	18	16
21GCCP20-19	20	19
21GCCP25-19	25	19
21GCCP30-19	30	19

⚠ ติดตั้งด้วยการใช้เฟลยาวยันท้ายของปลั๊กอุดรูน้ำเอาไว้แล้วใช้ไขควง ยาวขีดตัวปลั๊ก จะทำให้ตัวปลั๊กขยายตัวออกมาเบียดเข้ากับรูน้ำ
Install by using long rod to hold the Cooling Circuit Plug in place, then fasten it with long screw driver.

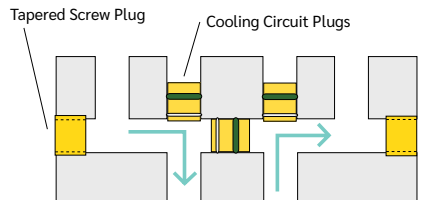
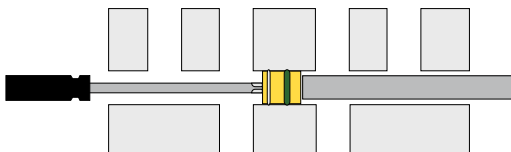

แบฟเฟิลบอร์ด

Baffle Board

FOIL FREE™

21ES/21AS

แบฟเฟิลบอร์ด เพื่อปรับทางเดินน้ำเพื่อการระบายความร้อนสูงสุด
Use for maximize the cooling water flow.

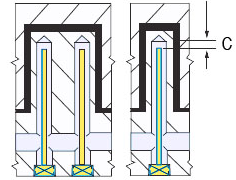
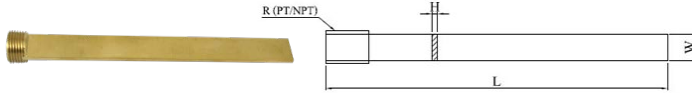

รูเจาะเพื่อติดตั้งเท่ากับ $W + 0.3\text{mm}$. (H13)
ระยะห่าง C เป็นการประมาณคร่าวๆ
Drill hole equal to $W + 0.3\text{mm}$. (H13)
Clearance C is approximate.

ORDER EXAMPLE

Model - Nominal - L
21ES-02-125

Ⓜ Brass

⚠ เกลียวสามารถเลือกได้ระหว่าง PT และ NPT
Choose between PT or NPT thread

PT Model	Nominal	L (mm)	R	W (mm)	H (mm)	C (mm)
21ES	01	100 200	1/8PT	8.2	2	3
	02	125 250	1/4PT	11.2	2.5	4.5
	03	150 300	3/8PT	14.7	2.5	5.5
	04	200 400	1/2PT	18.2	2.5	6.5
	06	300 350	3/4PT	23.2	3	9
	08	400 600	1PT	26.7	3	10.5

NPT Model	Nominal	L (Inch)	R	W (Inch)	H (Inch)	C (Inch)
21AS	01	4 8	1/8NPT	5/16	1/16	0.12
	02	5 10	1/4NPT	7/16	3/32	0.17
	03	6 12	3/8NPT	9/16	3/32	0.21
	04	8 16	1/2NPT	11/16	3/32	0.26
	06	12 20	3/4NPT	15/16	1/8	0.35
	08	16 24	1NPT	1 1/8	1/8	0.42

แบฟเฟิลบอร์ด แบบเกลียว

Spiral Baffle Board

FOIL FREE™

21ESS/21ASS

แบฟเฟิลบอร์ด เพื่อปรับทางเดินน้ำเพื่อการระบายความร้อนสูงสุด
Use for maximize the cooling water flow.

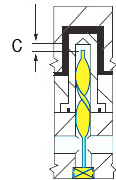
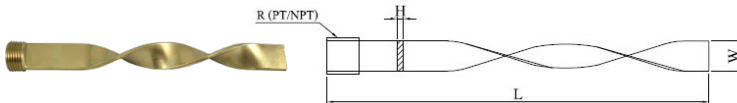

รูเจาะเพื่อติดตั้งเท่ากับ $W + 0.3\text{mm}$. (H13)
ระยะห่าง C เป็นการประมาณคร่าวๆ
Drill hole equal to $W + 0.3\text{mm}$. (H13)
Clearance C is approximate.

ORDER EXAMPLE

Model - Nominal - L
21ESS-02-125

Ⓜ Brass

⚠ เกลียวสามารถเลือกได้ระหว่าง PT และ NPT
Choose between PT or NPT thread

PT Model	Nominal	L (mm)	R (PT)	W (mm)	H (mm)	C (mm)
21ESS	01	100 200	1/8PT	8.2	2	3
	02	125 250	1/4PT	11.2	2.5	4.5
	03	150 300	3/8PT	14.7	2.5	5.5
	04	200 400	1/2PT	18.2	2.5	6.5
	06	300 350	3/4PT	23.2	3	9
	08	400 600	1PT	26.7	3	10.5

NPT Model	Nominal	L (Inch)	R (NPT)	W (Inch)	H (Inch)	C (Inch)
21ASS	01	4 8	1/8NPT	5/16	1/16	0.12
	02	5 10	1/4NPT	7/16	3/32	0.17
	03	6 12	3/8NPT	9/16	3/32	0.21
	04	8 16	1/2NPT	11/16	3/32	0.26
	06	12 20	3/4NPT	15/16	1/8	0.35
	08	16 24	1NPT	1 1/8	1/8	0.42

วอเตอร์คอร์ เกลียวเดี่ยว

Single Spiral Water Core

21SST

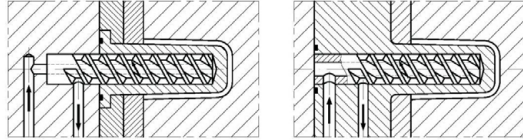
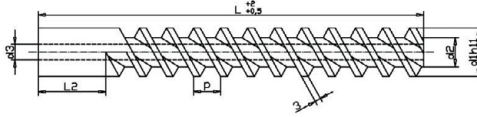

ORDER EXAMPLE Model d1 - L
21SST20-250 Aluminum

Model	d1	L	d2	d3	P	L2
21SST	12	150 / 175 / 200 / 250 / 300 / 400	8	5	14	35
	16		11	6		
	20		13	8		
	25		15	10	18	
	32		22	12		
	40		26	14		
	50		32	16		

วอเตอร์คอร์ เกลียวคู่

Double Spiral Water Core

21DST

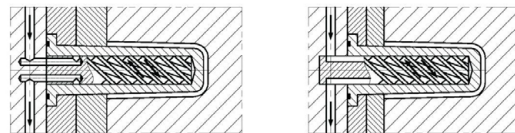
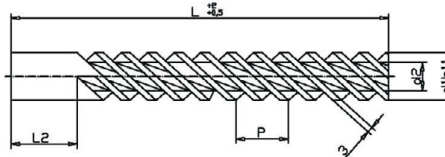

ORDER EXAMPLE Model d1 - L
21DST20-250 Aluminum

Model	d1	L	d2	P	L2
21DST	12	150 / 175 / 200 / 250 / 300 / 400	8	28	35
	16		11		
	20		13		
	25		15		
	32		22	36	
	40		26		
			32		
			50		

คาสแคดน้ำ รุ่นไหลเร็ว

High Flow Cascade

21CHF

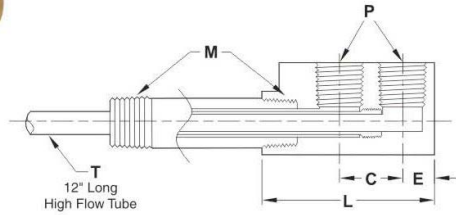
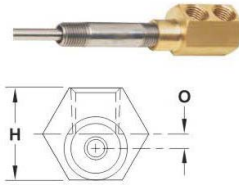

ORDER EXAMPLE

Model M - P - C
21CHF1/4-1/4-1.00

Head : Brass
Nipple : Galvanized Steel
Tube : Stainless Steel

Model	M (NPT)	P (NPT)	C (Inch)	T (Inch)	H (Inch)	O (Inch)	E (Inch)	L (Inch)
21CHF	1/16	1/16	0.50	0.125	0.62	0.094	0.25	1.25
			0.68	0.187	0.75	0.094	0.31	1.62
	1/8	1/8	1.00	0.187	0.75	0.094	0.31	1.93
			0.68	0.250	1.00	0.156	0.34	1.87
	1.00	0.250	1.00	0.156	0.34	2.18		
3/8	1/4	1.00	0.375	1.12	0.125	0.34	2.25	

คาสแคดน้ำ รุ่นหัวหกเหลี่ยม

Hex Key Cascade

21CHK

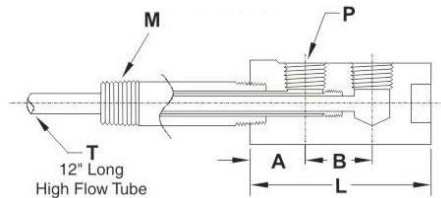
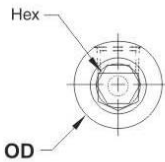

ORDER EXAMPLE

Model M - P - B
21CHK1/4-1/4-1.00

Head : Brass
Nipple : Galvanized Steel
Tube : Stainless Steel

Model	M (NPT)	P (NPT)	B (Inch)	T (Inch)	L (Inch)	A (Inch)	Hex (Inch)	OD (Inch)	Nominal Clearance (Inch)
21CHK	1/16	1/16	0.56	0.125	1.625	0.50	3/16	0.610	5/8
			0.56	0.187	1.687	0.56		0.735	3/4
	1/8	1/8	0.68	0.187	1.875	0.56	3/8	0.860	7/8
			1.00	0.187	2.187	0.56		0.860	7/8
	1/4	1/8	0.68	0.250	2.187	0.81	1.2	0.985	1
			1.00	0.250	2.500	0.81		0.985	1
		1/4	0.68	0.250	2.312	0.87		0.985	1
			1.00	0.250	2.625	0.87		0.985	1
	3/8	1/4	1.00	0.312	2.625	0.87	0.985	1	
	1/2	1/4	1.00	0.375	2.812	1.00	1.235	1-1/4	

คาสแคดน้ำ รุ่นคอมแพ็ค

Compact Cascade

21CACC



High Flow Tube is offset to achieve maximum flow

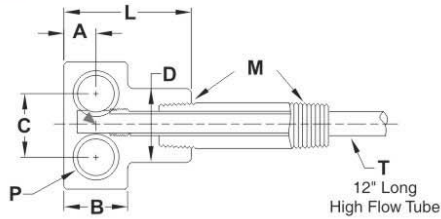
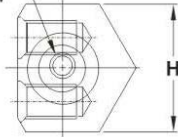

ORDER EXAMPLE

Model M - P
21CACC1/4-1/4

Ⓜ Head : Brass
Nipple : Galvanized Steel
Tube : Stainless Steel

Model	M (NPT)	P (NPT)	C (Inch)	T (Inch)	H (Inch)	A (Inch)	B (Inch)	L (Inch)	D (Inch)
21CACC	1/8	1/16	0.50	0.187	0.93	0.21	0.437	1.00	0.625
	1/4	1/8	0.68	0.250	1.25	0.31	0.625	1.25	0.750
		1/4	0.75	0.250	1.50	0.37	0.750	1.50	0.875
	3/8	1/4	0.75	0.312	1.50	0.37	0.750	1.50	1.000

คาสแคดน้ำ รุ่นสมนนิปเปิ้ล

Nipple Type Cascade

21CNT

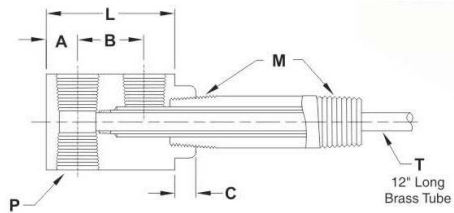
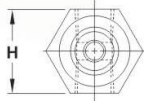

ORDER EXAMPLE

Model M - P - B
21CNT1/4-1/4-1.00

Ⓜ Head : Brass
Nipple : Galvanized Steel
Tube : Stainless Steel

Model	M (NPT)	P (NPT)	B (Inch)	T (Inch)	H (Inch)	A (Inch)	C (Inch)	L (Inch)
21CNT	1/8	1/16	0.50	0.187	0.75	0.21	0.28	0.937
		1/8	0.68	0.187	0.87	0.32	0.28	1.343
			1.00	0.187	0.87	0.32	0.28	1.656
	1/4	1/8	0.68	0.250	1.00	0.32	0.21	1.343
			1.00	0.250	1.00	0.32	0.43	1.656
		1/4	0.68	0.250	1.00	0.32	0.21	1.343
			1.00	0.250	1.00	0.32	0.43	1.656
	3/8	1/8	1.00	0.312	1.00	0.34	0.40	1.687
		1/4	1.00	0.312	1.00	0.34	0.40	1.687
	1/2	1/4	1.00	0.437	1.25	0.40	0.56	1.812
	3/4	3/8	1.25	0.625	1.50	0.50	0.75	2.250

ข้อต่อหัวหกเหลี่ยม แบบหักศอก

Hex Key Extension Elbow

FOIL FREE™

21EKL

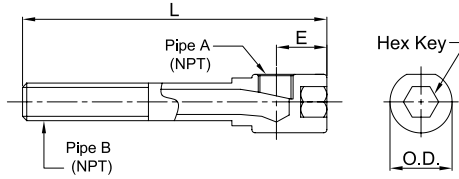

ORDER
EXAMPLE

Model A - B - L
21EKL1/4-1/4-5-1/2

Brass

Model	A (NPT)	B (NPT)	L (Inch)							E (Inch)	O.D. (Inch)	Hex Key (Inch)	
21EKL	1/16	1/16	2-1/2	4	5-1/2	7	8-1/2	10	11-1/2	13	0.531	0.552	1/4
	1/8	1/8									0.580	0.615	5/16
	1/4	1/4									0.660	0.860	3/8
	3/8	3/8									0.780	0.985	1/2
	1/2	1/2									0.940	1.235	1/2

ชุดแมนิโฟลด์เครื่องฉีดพลาสติก 1 ท่อเข้า

Mold Cooling Manifold 1 Main Tube

FOIL FREE™

21AL

ORDER
EXAMPLE

Model - Color
21AL01x08-R

Body : Aluminum
Fittings : Brass

1 Main Tube

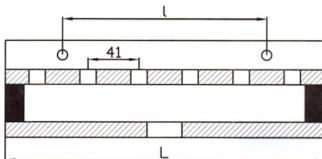

Model	Color	IN / OUT	L	l	Main Tube
21AL01X02	B (ด้ามฟ้า, blue handle)	2	92	-	1"
21AL01X03		3	133	42	
21AL01X04		4	174	83	
21AL01X05		5	215	124	
21AL01X06	R (ด้ามแดง, red handle)	6	256	165	
21AL01X07		7	297	203	
21AL01X08		8	338	247	
21AL01X10		10	420	249	
21AL01X12		12	502	411	

ชุดแมนิโฟลด์เครื่องฉีดพลาสติก 2 ท่อเข้า

☉ OIL FREE™

Mold Cooling Manifold 2 Main Tubes

21AL

2 Main Tubes

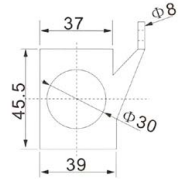
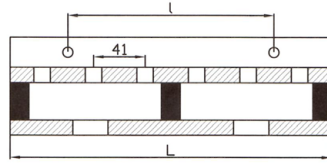

2 Main Tubes & Valves



Order Code		IN / OUT	L	l	Main Tube
No Valve	With Valve				
21AL02X02	21ALV02X02	2 x 2	174	83	1"
21AL03X03	21ALV03X03	3 x 3	256	165	
21AL04X04	21ALV04X04	4 x 4	338	247	
21AL05X05	21ALV05X05	5 x 5	420	329	
21AL06X06	21ALV06X06	6 x 6	502	411	
21AL07X07	21ALV07X07	7 x 7	584	493	
21AL08X08	21ALV08X08	8 x 8	666	575	
21AL10X10	21ALV10X10	10 x 10	830	739	
21AL12X12	21ALV12X12	12 x 12	994	903	



❗ ในชุดมาพร้อมกับฟิตติ้งรุ่น A 401
Standard set come with fitting A 401

❗ ใช้ร่วมกับเกลียว 3/8PT
Use with 3/8PT thread



❗ สามารถเปลี่ยนฟิตติ้งเป็นชิ้นส่วนอื่นๆที่เป็นเกลียว 3/8PT ได้
Can change the nipples to other fittings with 3/8PT thread

ชุดแมนิโฟลด์เครื่องฉีดพลาสติก แบบพิเศษ

☉ OIL FREE™

Special Mold Cooling Manifold

ชุดแมนิโฟลด์ สำหรับเครื่องฉีดพลาสติก สามารถประกอบพิเศษตามแบบได้
Manifold can be design and assemble upon special request



21AL01x01-TSB-LMH0997



21AL02x02-TSB



21AL04x04-TSB

❗ รุ่นประกอบพิเศษที่มีโค้ดมาตรฐาน
Special manifolds with standard order code

ชุดแมนิโฟลด์เครื่องฉีดพลาสติก พร้อมเกจวัด

Fine Mold Cooling Manifold

FOIL FREE™

21LT

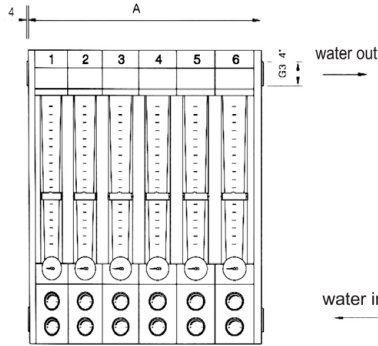

Max Pressure	Max Temperature
4 bar	120°C
6 bar	100°C
8 bar	80°C
10 bar	60°C

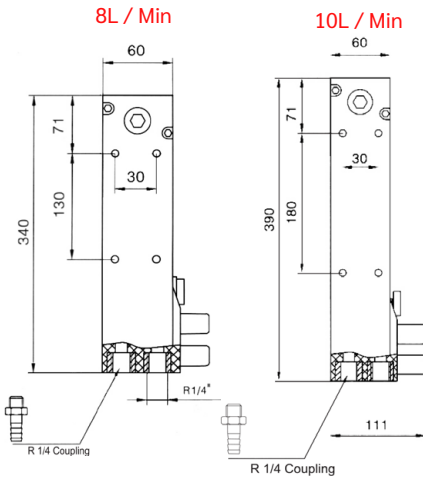

Order Code		IN/OUT	A	Main Tube
8L / Min	10L / Min			
21LT-100-080	21LT-100-100	1 x 1	72	G3/4"
21LT-200-080	21LT-200-100	2 x 2	124	
21LT-300-080	21LT-300-100	3 x 3	177	
21LT-400-080	21LT-400-100	4 x 4	229	
21LT-500-080	21LT-500-100	5 x 5	282	
21LT-600-080	21LT-600-100	6 x 6	334	
21LT-700-080	21LT-700-100	7 x 7	387	
21LT-800-080	21LT-800-100	8 x 8	439	
21LT-1000-080	21LT-1000-100	10 x 10	543	
21LT-1200-080	21LT-1200-100	12 x 12	647	



SUNRISE

Agent/Distributor

บริษัท ซันไรส์ เทคโนโลยี จำกัด

969 หมู่ 5 ถ.แพรกษา ต.แพรกษาใหม่
อ.เมืองสมุทรปราการ, จ.สมุทรปราการ, 10280

SUN RISE TECHNOLOGIES Co.,LTD.

969 moo 5 Praksa Rd., Praksa Mai
Muang Samuthprakarn, Samuthprakarn, 10280, Thailand

Website: sunrise.co.th

Tel: +662-030-0092 **Fax:** +662-324-3190

Email: sale@sunrisegr.com **LINE** @sunrisegroup